

SC-KD4

4 METRE SICAK DALDIRMA

GALVANİZ KAPLI KAMERA DİREĞİ



Teknik Özellikler

Alt Gövde Çapı	: 101 mm
Alt Gövde Uzunluğu	: 100 cm
Üst Gövde Çapı	: 76 mm
Üst Gövde Uzunluğu	: 3 m
Gövde Kalınlığı	: 3 mm
Rüzgara Dayanıklılık	: 90 km/h
Taban Plakası	: 8 mm x 230 mm x 230 mm
Direk Temeli	: 3 x M12 Ankraj - Ankraj Dik Boyu : 390 mm - Ankraj Toplam Boyu : 432 mm



Technical Specifications

Lower Body Diameter	: 101 mm
Lower Body Length	: 100 cm
Upper Body Diameter	: 76 mm
Upper Body Length	: 3 m
Body Thickness	: 3 mm
Wind Durability	: 90 km/h
Base Plate	: 8 mm x 230 mm x 230 mm
Pole foundation	: 3 x M12 Anchor - Anchor Vertical Height : 390 mm - Anchor Total Length : 432 mm

Levha Standardı
Plate Standart
EN10025

Üretim Standardı
Production Standart
EN40-5

Galvanizleme Standardı
Galvanising Standart
TSE EN 1461

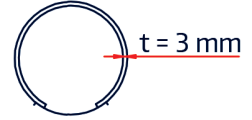
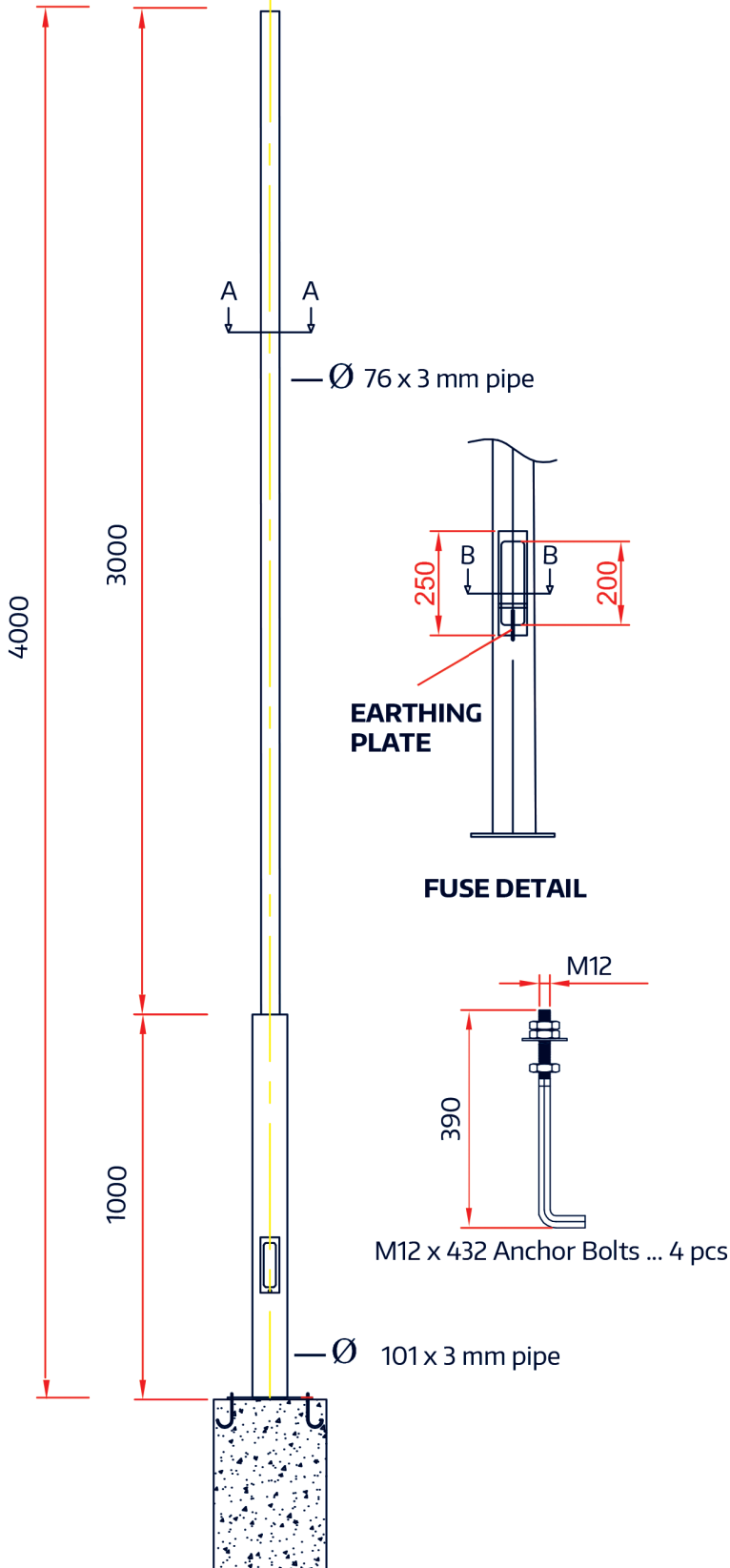

A - A Section

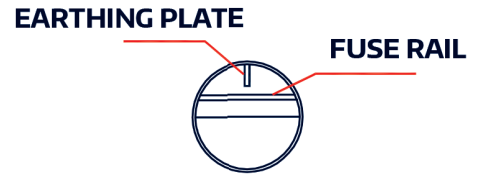

B - B Section



EARTHING PLATE

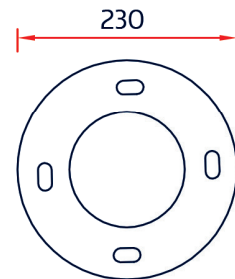

BASE PLATE

8 mm x 230 x 230